

PS Platinum
SPAS



HOT TUB MANUAL

WELCOME

Please take the time to read the entire manual before operating your hot tub or swim spa. This manual holds vital information and will introduce you to the operation of your new hot tub or swim spa and general maintenance required.

Every effort has been made to ensure the accuracy of this owner's manual, however the specification or design may vary depending on the model. If you have any questions about any aspect of your set up, operation or maintenance, contact your authorised hot tub retailer or Platinum Spas.

We hope your hot tub or swim spa will provide many years of fun and relaxation.

**YOUR JOURNEY TO ULTIMATE
RELAXATION STARTS HERE.**

REGISTER YOUR HOT TUB

Please take a moment to complete your details below. This will be useful in the future if you need to contact your hot tub retailer regarding your hot tub or when you require a service.

My Hot Tub Record

Please fill in the information below and save these instructions for future reference.

We will request this information upon submission of a service request.

Your Name –

Date of Purchase –

Hot Tub or Swim Spa model –

Date of Installation –

Hot Tub retailer –

Retailer Address –

Control System Number (please tick)

Balboa TP500

Balboa TP700

Balboa SpaTouch

Serial Number –

(Located in the equipment compartment of your hot tub)

CONTENTS

PREPARATION – 06

Electrical requirements – 08

Electrical installation – 10

Installation and positioning – 12

Air source heat pumps – 18

Before you use your hot tub – 20

ENJOYING YOUR HOT TUB AND SWIM SPA – 22

Control Panel Operation – 24

Components and Features – 32

Jet Design and Formation – 34

Jets and Valves – 36

Equipment Cabin – 38

Maintenance – 40

Diverter and Valve – 42

Bluetooth – 44

Filter Care – 48

Cleaning Your Hot Tub – 50

Hot Tub Servicing – 52

IMPORTANT INFORMATION – 54

Safety Information – 56

Troubleshooting – 58



PREPARATION

Electrical requirements – 08

Electrical installation – 10

Installation and positioning – 12

Air source heat pumps – 18

Before you use your hot tub – 20

ELECTRICAL REQUIREMENTS

Before installing a hot tub or swim spa, it is necessary to have your electrical supply fitted. You will require a 13, 32 or 40 amp supply (check with your supplier for the requirements for a swim spa) depending on which model you have purchased. Electrical requirements vary on each model, please check specifications on individual spas.

Before your hot tub arrives, please arrange for a qualified electrician to do the following:

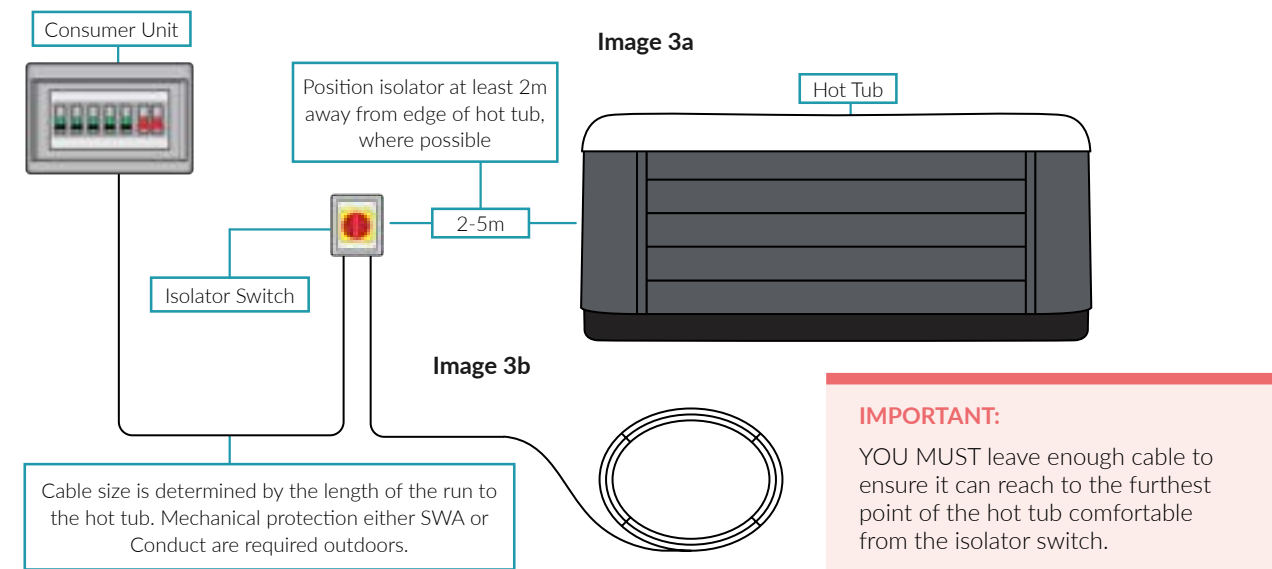

Image 1



Image 2

32 or 40 amp supply

1. Add 32 or 40 amp Type B Or C breaker to the consumer unit (see image 1)
2. From the main consumer unit, run a 6mm, 3 Core Armoured Cable to the Rotary Isolator Switch (see image 2)
3. Rotary Isolator Switch should be 2-5m from the hot tub (see image 3a)
4. The installing electrician will decide whether an earth rod is needed or not
5. Another 6mm, 3 Core Armoured Cable must be connected to the Rotary Isolator Switch with a minimum of 10m worth of cable left in a loop. Our delivery team are qualified to connect this cable to the inside of the hot tub. However, they will NOT hard-wire your hot tub to the mains supply (see image 3b)
6. Your electrician should leave enough spare cable attached to the isolator to reach the side panel where the control panel is. More is better than not enough
7. A Part P certificate should be supplied by your electrician. This is to confirm that the electrical work is in line with government regulations. This paperwork must be kept on file and presented when requested.



13 amp supply

Our 13 amp hot tubs do not come with a cable or plug. These will need to be sourced and supplied by you.

The hot tub needs to have its own circuit from the main distribution board, the supply should not be shared.

Please arrange for an electrician to do the following before the delivery day:

1. Install a 16 amp outdoor waterproof commando socket with RCD protection. Install an earth rod (If required)
2. Provide a 2.5mm 3 Core Armoured Cable and 16amp commando plug with a minimum of 10m worth of cable left in a loop. Our delivery team are qualified to connect this cable to the inside of the hot tub. However, they will NOT hardwire your hot tub to the mains supply.
3. Ensure the outdoor socket is within 2-5m from the hot tub.
4. Our 13amp hot tubs potentially could be installed with a 13amp plug into a standard socket. This would need to be a dedicated supply from your main distribution board and we recommend you consult with your electrician to ensure this is suitable. However our recommendation is that you install the 16amp commando socket to avoid any future problems

IMPORTANT:

The relevant steps must be completed before we deliver your hot tub. Failure to do so will mean that we cannot install your hot tub.

For 13, 32 and 40 amp supply hot tubs we recommend your electrician installs an earth rod to ensure the earthing systems voltage is the same as the ground you are standing on. This will prevent the voltage traveling through you and any tingling.

ELECTRICAL INSTALLATION

Electrical requirements vary on each model, please check specifications on individual spas. All electrical connections need to be done by a certified electrician.

However, you must meet the following specification:

- The hot tub should be appropriately protected by a sufficiently rated MCB (main circuit breaker) and should cover the maximum amperage pull of the hot tub. A hot tub that has a maximum current draw of 30 amps should be fitted with a 32amp MBC. The surge current of the pumps (i.e. the rush of current when pumps are first turned on) can play a factor within the electrical install. Some installations may require a type c MCB, but this will be decided by your electrician.
- Your hot tub should be protected against earth faults also, by an RCD (residual current device). This is a trip switch which works to prevent the danger of electric shocks from damaged or waterlogged cables and connections. A suitable rated 30Ma RCD is what is recommended.
- Any outdoor cabling should be suitably protected from damage by either laying protective ducting (pc pipe) below ground or by using a SWA (steel wired armoured) cable. Your electrician will calculate the size of cable required dependent upon loading and the distance from the mains supply.

Emergency/service work

An IP65 Rotary Isolator switch is recommended for the hot tub to be isolated outdoors in an emergency or for service work. This is simply a rotary on/off switch that should be sited more than 2m away from the hot tub so that individuals cannot be in the hot tub whilst touching the switch.

PLEASE NOTE:

Your electrician should leave at least 10m of spare cable attached to the isolator to reach the side panel where the control panel is. The delivery team are qualified to connect this cable to the inside of the hot tub however they will NOT hardwire your hot tub to the isolation switch.

If you are in any doubt at all about the required electrical guidelines you should seek professional advice from a fully qualified electrician.



INSTALLATION AND POSITIONING

Unwrapping your hot tub

The information within this section is for the installation team. For further information on where to position the hot tub please read the Pre-Delivery guide.



Inspect for damage

Carefully unwrap the hot tub and thoroughly inspect it for any damage. If you notice any transit damage to the product, please photograph the damage, keep all paperwork/labels and contact the retailer from which the hot tub was purchased immediately.



Wipe out excess water

Your hot tub has been thoroughly factory tested during the manufacturing process to ensure maximum reliability and long-term satisfaction. Wipe out any excess water from the hot tub that may have drained from the plumbing after testing and make sure it is clean prior to filling.



Remove filter tray & cartridges

Slide filter face upwards, then remove filter tray cover / take off filter lid and filter cartridges before filling. The number of filter cartridges varies depending on the model.



Rotate jets

Check the jets are fully secure and fitted into place before using the hot tub. Each jet had a quarter of a turn to turn the jet off and on. If you twist the jet anti clockwise harder than usual the jet will unscrew and come out

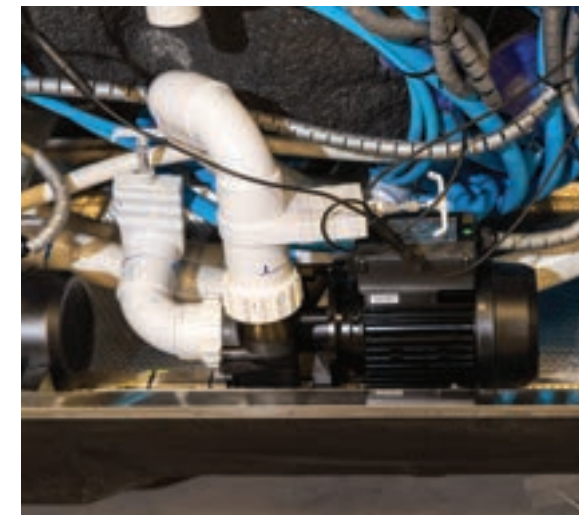

Check pump connection and release valves

Prior to filling your hot tub, remove the side panels where the engine compartment and control equipment are situated. Ensure all your pump connections are tight and release valves are open as they may have shifted during transit.



Check air controls

Ensure all air controls on the topside of your spa are turned to the 'off' position. Failure to turn off the air controls will extend your heat up time dramatically.

Hot Tub prior to filling



Check the drain valve

Check that the drain valve is fully closed before attempting to fill the hot tub.



Attaching cover lifter (Additional Extra)

Once the hot tub is in its final position, we recommend attaching your cover lifter before you fill your hot tub, to ensure enough clearance for the lifter mechanism to operate freely. Do not place too close to nearby walls. All cover lifters have different clearance parameters.



Access in cabinet power supply

If the hot tub is a plug and play (13amp) hot tub, the power cable will already be in place and therefore no extra work is required. If the hot tub is a 32amp (hard wired), this will require a cable wire to be connected. If you would prefer for the cable to be hidden, it may need to be drilled into one of the corners or the base. This will need to be completed by a professional.



Hot Tub equipment access

Please see step by step stages on how to remove the cabinet panel to gain access to plumbing location, electrical cabling conduit access to power control box.

Swim Spa prior to filling



Check the drain valve

Check that the drain valve is fully closed before attempting to fill the swim spa.

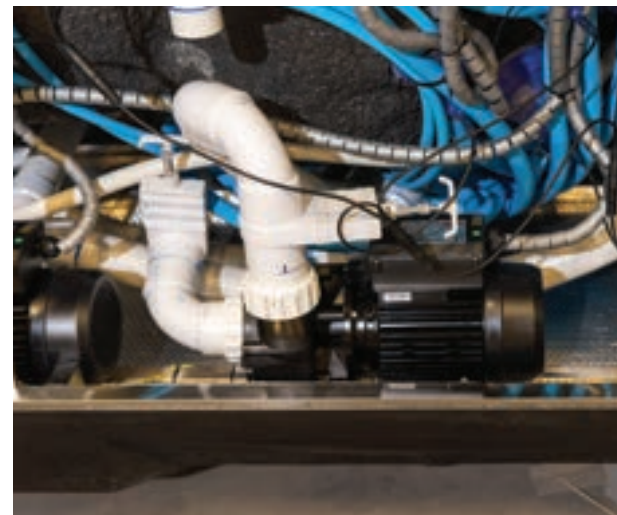

Check pump connection and release valves

Prior to filling your swim spa, remove the side panels where the engine compartment and control equipment are situated. Ensure all your pump connections are tight and release valves are open as they may have shifted during transit.



Attaching a swim tether (Additional Extra)

Simply place the tether pole into the hole (the hole will be already built into the swim spa). Once in place, screw the pole into the hole, ensuring it is tightly placed and there is no room for movement.

Swim Spa equipment access

Please see step by step stages on how to remove the cabinet panel to gain access to plumbing location, electrical cabling conduit access to power control box.



AIR SOURCE HEAT PUMPS

Air source heat pumps are an energy-efficient and economical way of heating your hot tub or swim spa. They can be used all year round giving great savings on energy bills.

They have already proved to be beneficial for heating homes, commercial spaces or swimming pools and now they have become increasingly popular for hot tubs.

Heat pumps make use of significantly less energy when compared to natural gas. Although the time taken to heat the water might be the same as their electric or gas-powered counterparts, the process is much more efficient and economical.

How does a heat pump work?

Heat pumps heat up the water by extracting natural heat from the outside air. The heat pump fan draws in the air and directs it over the evaporator coil which contains an advanced liquid refrigerant. The air turns into a gas which is then compressed to increase the heat. This hot gas passes through the heat exchanger which transfers the heat from the hot gas to water and heats it up.

Here are some of the benefits of heat pumps:

- Savings on hot tub heating bills
- Has the potential to heat up to temperature faster for a quick turnaround
- Works all year round and down to -15 degrees external temperature
- Self-regulating and timer controlled



Specification of the Air Source Heat Pump

Model Name – 50RC MINI	
Performance Conditions: Air 26 degrees in/Water 26 degrees in/Water 28 degrees out	
Capacity (KW)	5.37
Power input (KW)	0.67
COP	8.01

Performance Condition: Air 15 degrees in/Water 26 degrees in/Water 28 degrees out	
Capacity (KW)	5.37
Power input (KW)	0.67
COP	8.01

Weight & Dimensions	
Net weight (KG)	25kg
Net dimension (mm)	636 x 277 x 496

BEFORE YOU USE YOUR HOT TUB

The information within this section is for the installation team.

Fill it up

- Place a garden hose into the filter area. Let your hose run for five minutes before putting it in to clear out any stagnant water in the hose. It is advisable to use a hose-ended filter/water softener (if you are in a hardwater area). This will fill your hot tub from the pumps and pipework first to prevent any airlocks in the system. It will also make balancing water easier and to reduce the amount of impurities that can contaminate your water. At this point your hot tub should be turned off at the isolator.
- Fill water to recommended water level as indicated by the minimum water level. Low water levels can cause damage to the pump and heater element so is good practice to top up your hot tub on a weekly basis. If there is no water level indicator, you should fill your hot tub to 1 inch above the top of the back jets.
- Remove side panel and check for any leaks around the plumbing. Occasionally fittings may come loose during shipment. If you do detect any small leaks, you will need to hand-tighten them straight away. Do not use a wrench, as it can easily crack the nut and cause the leak to worsen.

Power up

You can now re-fit the side panel and turn the power on at the isolator point. Read the control panel section on how to operate it. Hot tubs can take approximately 12-24 hours to rise to temperature. Heat time depends on size, voltage and other factors such as outside temperature. Plug & Play hot tubs take longer to heat than 32AMP.

Balance your water

Test and balance your hot tub water before you introduce any sanitizers. It is important to balance prior to adding sanitizers to avoid unwanted problems such as cloudiness, discoloration or foul-smelling water. Also, keeping your water balanced is crucial for longevity of the hot tub and to keep your water clean and clear. Poor water management can result in components degrading/failing which can invalidate your warranty. More information on treating your water can be found in the Maintenance section.

IMPORTANT:

DO NOT put Chlorine Granules or Chlorine Tablets directly into the hot tub as it will bleach or blister the hot tub and swim spa.

Please refer to the Care & Maintenance Guide for further information.





ENJOYING YOUR HOT TUB AND SWIM SPA

Control Panel Operation – 24

Components and Features – 32

Jet Design and Formation – 34

Jets and Valves – 36

Equipment Cabin – 38

Maintenance – 40

Diverter and Valve Maintenance – 42

Bluetooth – 44

Filter Care – 48

Cleaning Your Hot Tub – 50

Hot Tub Servicing – 52

CONTROL PANEL OPERATIONS

All Platinum Spas hot tubs use the world leading Balboa control panels. For a more detailed interface manual please visit the Balboa website and select the control panel you have. The information provided below is a summary.

Balboa TP500

Overview

For a more detailed interface manual please visit the Support section on the [Balboa website](#) and select the TP500 manual.



The TP500 is part of Balboa's BP WIFI ready range and comes complete with a 4 black plastic pins connector. It is designed to work with the BP Series of hot tub control systems. The sleek panels have LCD displays that have moving function indicator icons, maintenance reminders, and service alerts on the easy-to-read screen. Please note you must have opted in to receive the WiFi option, this does not come as standard.

Brands

Platinum Spas Hot Tubs

Trident, Tahiti, Happy, Palma and Refresh

Platinum Spas Swim Spa

Zeus

Temperature

Adjusting the set temperature

When using a panel with Up and Down buttons (Temperature buttons), pressing Up or Down will cause the temperature to flash. Pressing a temperature button again will adjust the set temperature in the direction indicated on the button. When the LCD stops flashing, the spa will heat to the new set temperature when required. If the panel has a single temperature button, pressing the button will cause the temperature to flash. Pressing the button again will cause the temperature to change in one direction (e.g. UP). After allowing the display to stop flashing, pressing the Temperature Button will cause the temperature to flash and the next press will change the temperature in the opposite direction (e.g. DOWN).

Press-and-Hold

If a Temperature button is pressed and held when the temperature is flashing, the temperature will continue to change until the button is released. If only one temperature button is available and the limit of the Temperature Range is reached when the button is being held, the progression will reverse direction.

For the TP500 to be used at its max you need to have it on Ready mode and high range. This will let you have the temperature set to 40 and keep it set high.



Filter

Adjusting filtration

Main Filtration Filter cycles are set using a duration. The filter duration setting can be adjusted in 1-hour increments. Filter Cycle 1 and Filter Cycle 2 (if enabled) are set to the same duration.

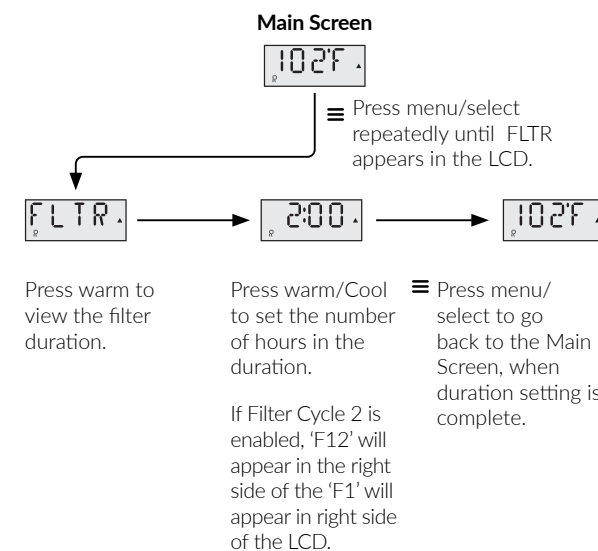

Heater-Related Message

Heater Flow is Reduced (HFL)

HTR FLOW LOSS

There may not be enough water flow through the heater to carry the heat away from the heating element. Heater start up will begin again after about 1 min. See *Flow Related Checks* below.

Heater Flow is Reduced (LF)*

HTR FLOW FAIL

There is not enough water flow through the heater to carry the heat away from the heating element and the heater has been disabled. See *Flow Related Checks* below. After the problem has been resolved, you must press any button to reset and begin heater start up.

Heater May be Dry (DR)*

HTR MAY BE DRY BAIT

Possible dry heater, or not enough water in the heater to start it. The spa is shut down for 15min. Press any button to reset the heater start-up. See *Flow Related Checks* below.

Heater is Dry*

HTR DRY

There is not enough water in the heater to start it. The spa is shut down. After the problem has been resolved, you must press any button to reset and restart heater start up. See *Flow Related Checks* below.

Heater is too Hot (OHH)*

PRES. BTTN. TO RESET

One of the water temp sensors has detected 118°F (47.8°C) in the heater and the spa is shut down. You must press any button to reset when water is below 108°F (42.2°C). See *Flow Related Checks* below.

A Reset Message may Appear with other Messages.

HTR TOO HOT

Some errors may require power to be removed and restored.

Balboa TP700

Overview

For a more detailed interface manual please visit the Support section on the [Balboa website](#) and select the TP700 manual.



The TP700 is designed with meticulous attention to detail to suit any user. With Balboa's new, subtle, navigational buttons that easily provide a smooth response with just a tap, the TP700 dramatically improves your hot tub experience.

Brands

Platinum Spas Hot Tubs

Arizona, Kenya, Santorini and Maximus

Platinum Spas Swim Spa

Ares, Poseidon, Apollo, Athena, Hera and Neptune.

Temperature

Adjusting the set temperature

- Start at the Main screen (A). Press the SELECT navigation button to view the temperature menu (E).
- Press the RIGHT and/or LEFT navigation buttons to change the Set Temperature. The centre box (D) indicates the current Set Temperature. In this example the current Set Temperature is 102.

- Once your desired Set Temperature is in the centre box (D), press the SELECT navigation button, or just wait a few seconds.
- The change is complete.

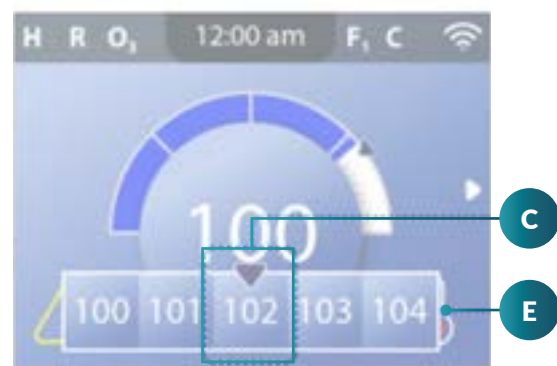

Filter

Set filter cycle times

Keep your water clean and ready to enjoy. Follow these steps to set the filter cycles:

- Navigate to Filter (A)
- Press the SELECT navigation button to view the Filter screen (B)
- Select the start time for Filter Cycle 1 (C). Press the SELECT navigation button to view the time controls (E)
- Enter your time settings (E) with the navigation buttons
- Select the Save button (D), and press the SELECT navigation button.

You have set the start time for Filter Cycle 1.

If you do not want to save your settings, select the Cancel button, and press the SELECT navigation button.

- Follow the same process to change the other Filter time settings if desired.
- Once all of the time changes are set, select the Save button, and press the SELECT navigation button.

You have set all of the Filter Cycle times.

How can you tell if Filter Cycle 2 is enabled?

Filter Cycle 2 is enabled when a white ring appears around the 2 (H). In this example there is no white ring, so Filter Cycle 2 is disabled. Filter Cycle 2 is disabled by default on many spas.

Adjusting filtration

Circulation Pump Modes Some spas may be manufactured with Circulation Pump settings that allow programming filtration cycle duration. Some Circulation Modes are pre-programmed to operate 24 hours a day and are not programmable. Refer to the spa manufacturer's documentation for any Circulation Pump Mode details.

Purge Cycles

In order to maintain sanitary conditions, as well as protect against freezing, secondary water devices will purge water from their respective plumbing by running briefly at the beginning of each filter cycle. (Some systems will run a certain number of purge cycles per day, independent of the number of filter cycles per day. In this case, the purge cycles may not coincide with the start of the filter cycle.) If the Filter Cycle 1 duration is set for 24 hours, enabling Filter Cycle 2 will initiate a purge when Filter Cycle 2 is programmed to begin.

The meaning of filter cycles

1. The heating pump always runs during the filter cycle*
2. In Rest Mode, heating only occurs during the filter cycle
3. Purges happen at the start of each filter cycle (on most systems). * For example, if your spa is set up for 24-hour circulation except for shutting Off when the water temperature is 3°F/1.5°C above the set temperature, that shut off does not occur during filter cycles.

Heater related messages

The water flow is low - M016

There may not be enough water flow through the heater to carry the heat away from the heating element. Heater start-up will begin again after about 1 minute. See "Flow Related Checks" below.



The water flow has failed - M017

There is not enough water flow through the heater to carry the heat away from the heating element and the heater has been disabled. After the problem has been resolved, reset the message.

The heater may be dry - M028

Possible dry heater, or not enough water in the heater to start it. The spa is shut down for 15 minutes. Reset this message to reset the heater start-up.

The heater is dry - M027

There is not enough water in the heater to start it. The spa is shut down. After the problem has been resolved, you must reset the message* to restart heater start up.

The heater is too hot - M030

One of the water temp sensors has detected 118°F (about 48°C) in the heater and the spa is shut down. You must reset the message when water is below 108°F (about 42°C).



Exit and clear buttons

Some messages can be reset from the panel. Messages that can be reset will appear with a Clear button (B). If the message has an Exit button (A), the Message icon will remain on the Main screen once you exit the Message screen.

Overview

The SpaTouch2T™ menu panel is compatible with all BP systems that already support the TP800 and/or the TP900.

For a more detailed interface manual please visit the Support section on the [Balboa website](#) and select the SpaTouch2T manual.



Brands

Platinum Spas Hot Tubs

Barcelona, Topaz and Infinity.

Platinum Spas Swim Spas

Eros, Zelus and Helios.

Temperature

Setting the temperature

Press Up or Down once to display the Set Temperature (indicated by a flashing °F or °C, plus a change in colour of the temperature). Press Up or Down again to modify the Set Temperature. The Set Temperature changes

immediately. If you need to switch between High Temperature Range and Low Temperature Range you need to go to the Settings Screen.

Press and hold

If Up or Down is pressed and held, the temperature will continue to change until you stop pressing, or until the Temperature Range limits are reached.

Filters

Main filtration



Using the same adjustment as Setting the Time, Filter Cycles are set using a start time and a duration. Each setting can be adjusted in 15-minute increments. The panel calculates the end time and displays it automatically.

Circulation Pump Modes

Some hot tubs may be manufactured with Circ Pump settings that allow programming filtration cycle duration. Some circ Modes are pre-programmed to operate 24 hours a day and are not programmable.

Purge Cycles

In order to maintain sanitary conditions, as well as protect against freezing, secondary water devices will purge water from their respective plumbing by running briefly at the beginning of each filter cycle. (Some systems will run a certain number of purge cycles per day, independent of the number of filter cycles per day. In this case, the purge cycles may not coincide with the start of the filter cycle). If the Filter Cycle 1 duration is set for 24 hours, enabling Filter Cycle 2 will initiate a purge when Filter Cycle 2 is programmed to begin.

The Meaning of Filter Cycles

- The heating pump always runs during the filter cycle*
- In Rest Mode, heating only occurs during the filter cycle
- Purges happen at the start of each filter cycle * For example, if your spa is set up for 24/hour circulation except for shutting off when the water temperature is 3°F/1.3°C above the set temperature, that shut off does not occur during filter cycles.

Heater-Related Messages

The water flow is low – M016

There may not be enough water flow through the heater to carry the heat away from the heating element. Heater start-up will begin again after about 1 min.

The water flow has failed – M017

There is not enough water flow through the heater to carry the heat away from the heating element and the heater has been disabled. After the problem has been resolved, reset the message.

The heater may be dry – M028

Possible dry heater, or not enough water in the heater to start it. The spa is shut down for 15 min. Reset this message to reset the heater start-up.

The heater is dry – M027

There is not enough water in the heater to start it. The spa is shut down. After the problem has been resolved, you must reset the message to restart heater start up.

The heater is too hot – M030

One of the water temp sensors has detected 118°F (47.8°C) in the heater and the spa is shut down. You must reset the message when water is below 108°F (42.2°C).



Flow-related checks

Check for low water level, suction flow restrictions, closed valves, trapped air, too many closed jets and pump prime. On some systems, even when spa is shut down by an error condition, some equipment may occasionally turn on to continue monitoring temperature or if freeze protection is needed.

Some messages can be reset from the panel. Messages that can be reset will appear with a Clear Icon at the bottom of the Message Screen. Press the Clear Icon text to reset the message.

Overview

Important information about spa operations can be seen on the Main Screen. Most features can be accessed from this screen.

For a more detailed interface manual please visit the Support section on the [Balboa website](http://www.balboa.com) and select the SpaTouch 3 manual.



Brands

Platinum Spas Hot Tubs
Onyx

Temperature

When the spa is powered On, four dashes appear in the Water Temperature display for one minute. The dashes indicate that the spa is checking the water temperature. After the pump runs for 1 minute, the dashes disappear and the water temperature is displayed. The dashes may reappear after the pump has not run for one hour.

Set Temperature

In this example we will set the Set Temperature to 102.

- Press the water temperature display button (A) to make the temperature menu appear (B). The centre box with the arrow (C) indicates the current Set Temperature.
- If 102 is already showing, but just not centred (D), touch it to centre it (E).
- If 102 is not showing (B), swipe the temperature menu until 102 appears (D).
- If 102 appears after swiping but does not stop in the centre box (D), press 102. Pressing 102 makes it shift to the centre box (E).
- Press the water temperature display (A) to make the temperature menu disappear. The Set Temperature is now 102.

The center of the Heater Status icon  turns red (F) when the heater is On.

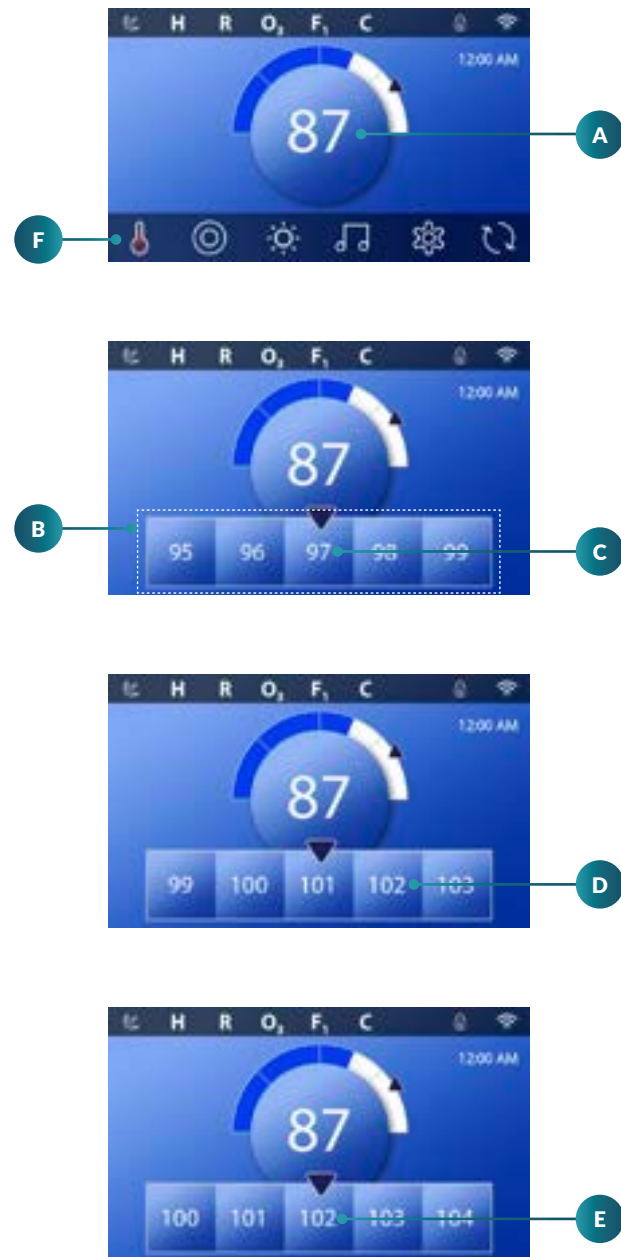

Filter

Kepp your water clean and ready to enjoy.

Follow these steps to set the time for Filter Cycle 1.

- Press the Settings button (A) on the Main screen.
- Press the Filter button (B) on the Settings screen.
- Press the Start button (E) on the Filter Cycles screen.
- Set the Start Time with these dials (J) on the F1 End screen.
- Press the Save button (K) to save your settings, or press the Cancel button (I) to cancel your settings.
- Press the End button (F) on the Filter Cycles screen, and follow the same steps to set the End Time.
- Once the Start and End Times are set, press the Save button (G) on the Filter Cycles screen.
- Once Start and End Times are set, the Duration appears here (H). You have now set the time for Filter Cycle 1. The white ring (C) indicates that Filter Cycle 1 is enabled (it is always enabled). Follow the same steps noted above to set the time for Filter Cycle 2.

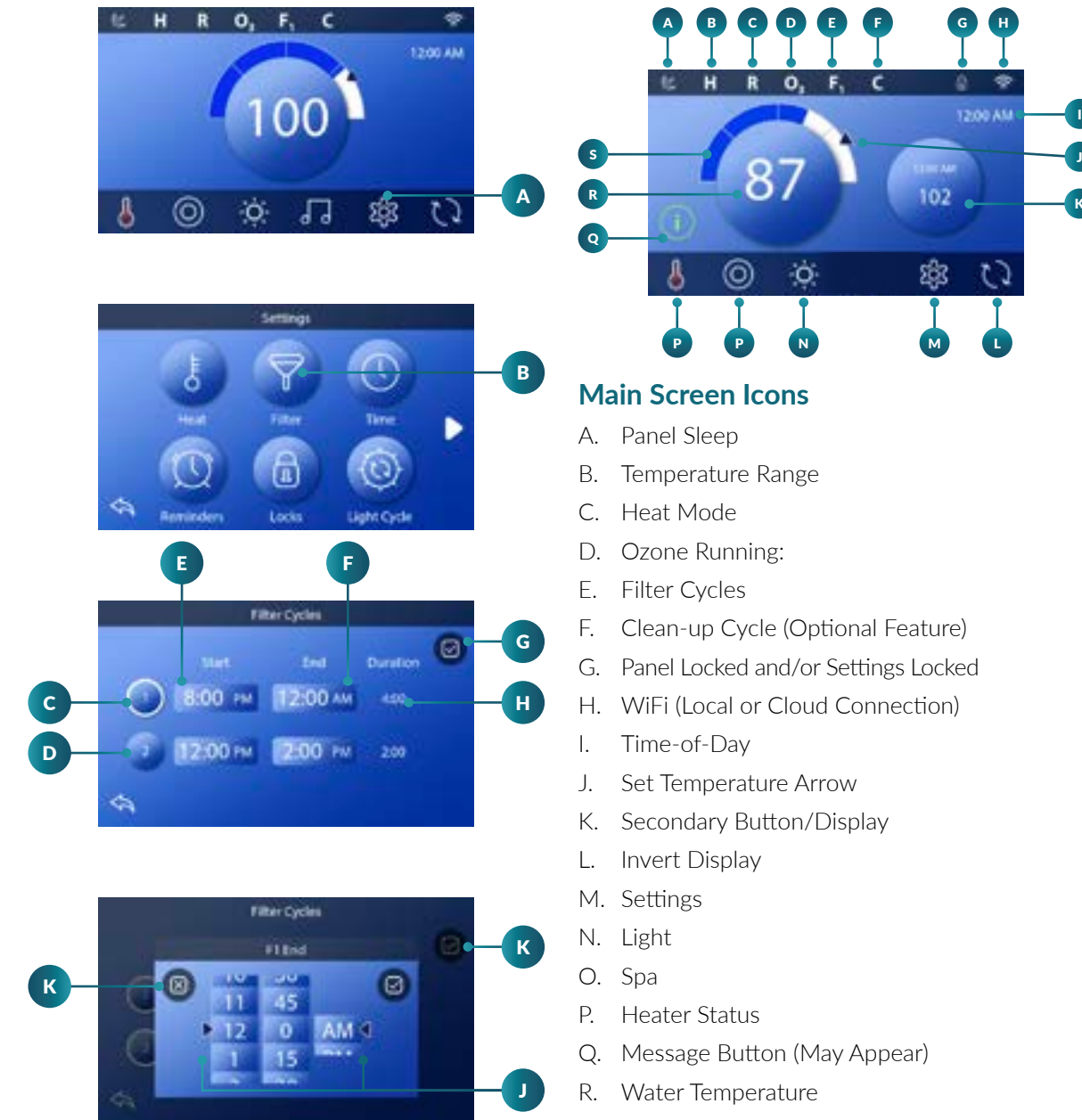

Main Screen Icons

- A. Panel Sleep
- B. Temperature Range
- C. Heat Mode
- D. Ozone Running:
- E. Filter Cycles
- F. Clean-up Cycle (Optional Feature)
- G. Panel Locked and/or Settings Locked
- H. WiFi (Local or Cloud Connection)
- I. Time-of-Day
- J. Set Temperature Arrow
- K. Secondary Button/Display
- L. Invert Display
- M. Settings
- N. Light
- O. Spa
- P. Heater Status
- Q. Message Button (May Appear)
- R. Water Temperature
- S. Water Temperature Bar

COMPONENTS AND FEATURES



Jets and Valves

Your new hot tub or swim spa will include a variety of jets which will provide a hydrotherapy massage and will offer you various massage modes.

To find your suitable mode: adjust the diverter valves and the air regulating valves.
(See page 34 for jet descriptions)



Diverter Valves

The diverter Valves are the largest valves and allow you to divert the water from one seat to another. Adjusting the diverter valve allows you to increase the pressure in one seat and reduce in another. When the diverter is in the middle, even pressure will flow throughout the different seats that the diverter controls.

Important: when the diverter is in the 'middle position' the jets cannot provide the maximum pressure.



Waterfall Valve

Some hot tubs are equipped with a waterfall feature. To start this, please turn on one of the jet pumps then turn the waterfall diverter clockwise until the waterfall appears.

By opening and closing the waterfall diverter on the hot tub surface, you can adjust the water flow from high to low.



Air Regulating Valve

The air control function allows you to enjoy massages with different pressures from the jets. By turning the air regulator on, you can control the jet pressure by adding more air into the water flow.

Some seats will not work off of these regulators and will instead have an air manifold inside the hot tub that will constantly allow air into the jets.



JET DESIGN AND FORMATION

More jets do not equal a better hydromassage, but the right jets do. Utilising the perfect mix of air and water – to deliver a massage that reduces stress and lower back pain, improves sleep and post exercise recovery. It will also alleviate restless leg syndrome, cramps, arthritis and fibromyalgia, improving your overall well-being.

A regular hydromassage routine can be more beneficial than you realise. Seat designed to follow the contours of the body and recessed jets are placed to perfectly match the muscle structure of the human form, which delivers a comfortable, premium hydromassage experience for most body types.

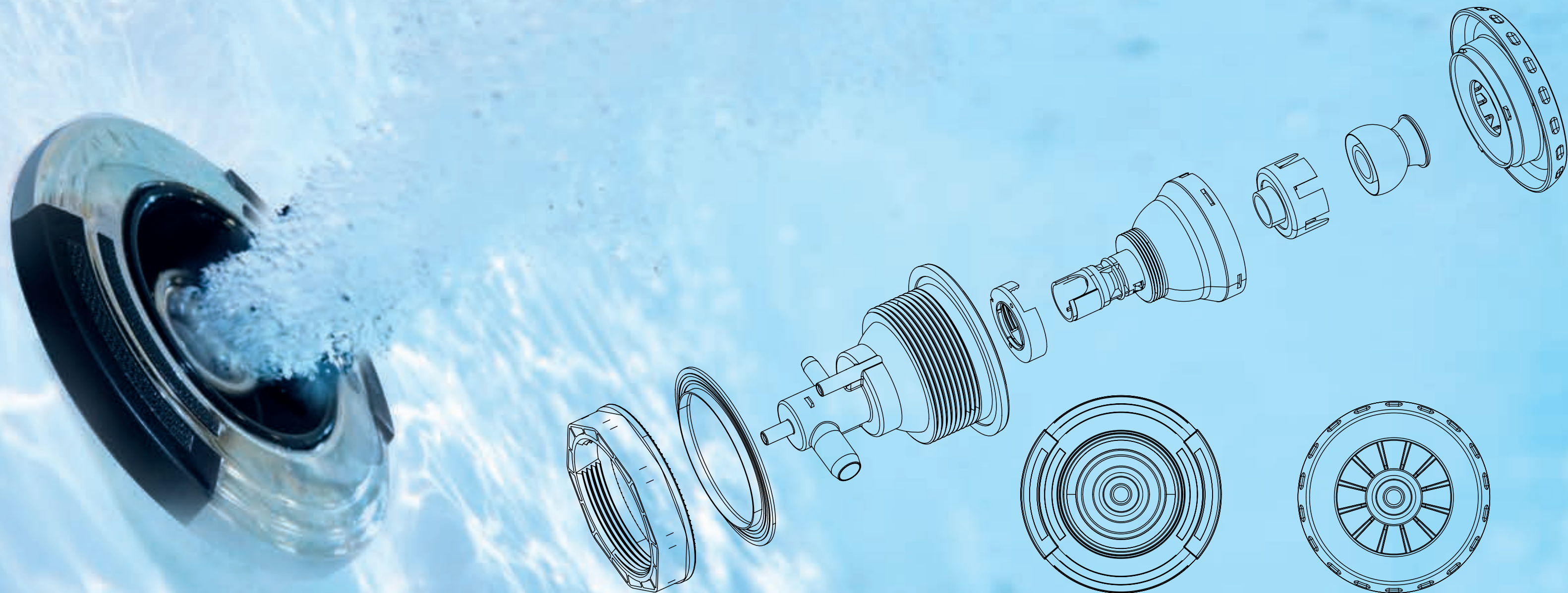

JETS AND VALVES

Jets and valves may vary depending on model.



Diffuser jet

The Diffuser gives a different type of massage by being more open/broad. Its not as direct and will massage a greater area compared to the directional jets.



Directional adjusting jet

Massage intensity can be adjusted with the jet: the intensity reduces by turning the decor ring clockwise and increases by turning anti-clockwise.

Please note; the water flow from other jets can increase when the water flow of a jet part is closed.



Directional rotating jet

This jet provides a soft pulsating massage. It will also provide the massage to a greater area of your back. If you would like to receive more pressure out of this jet, turn the diverter so all the pressure is going to this seat.



Air regulator

Air controls are located on the top edge of the spa shell (most hot tubs). Once rotated and turned on they allow water flowing through the jets to suck air into the venturi, adding extra bubbles.



EQUIPMENT CABIN

*Illustration varies on each model

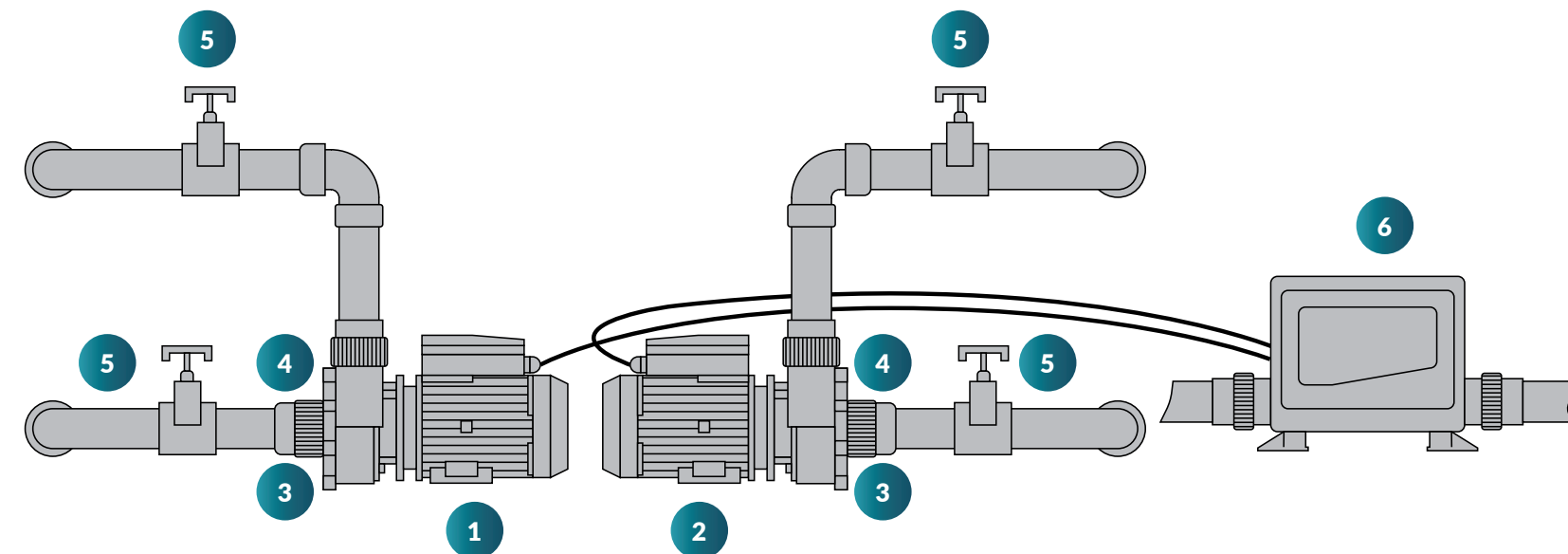

Side view of jet pump

- | | | |
|---------------|---------------|-----------------------|
| 1. Jet pump 1 | 3. Pump union | 5. Gate valve |
| 2. Jet pump 2 | 4. Pipe joint | 6. System control box |

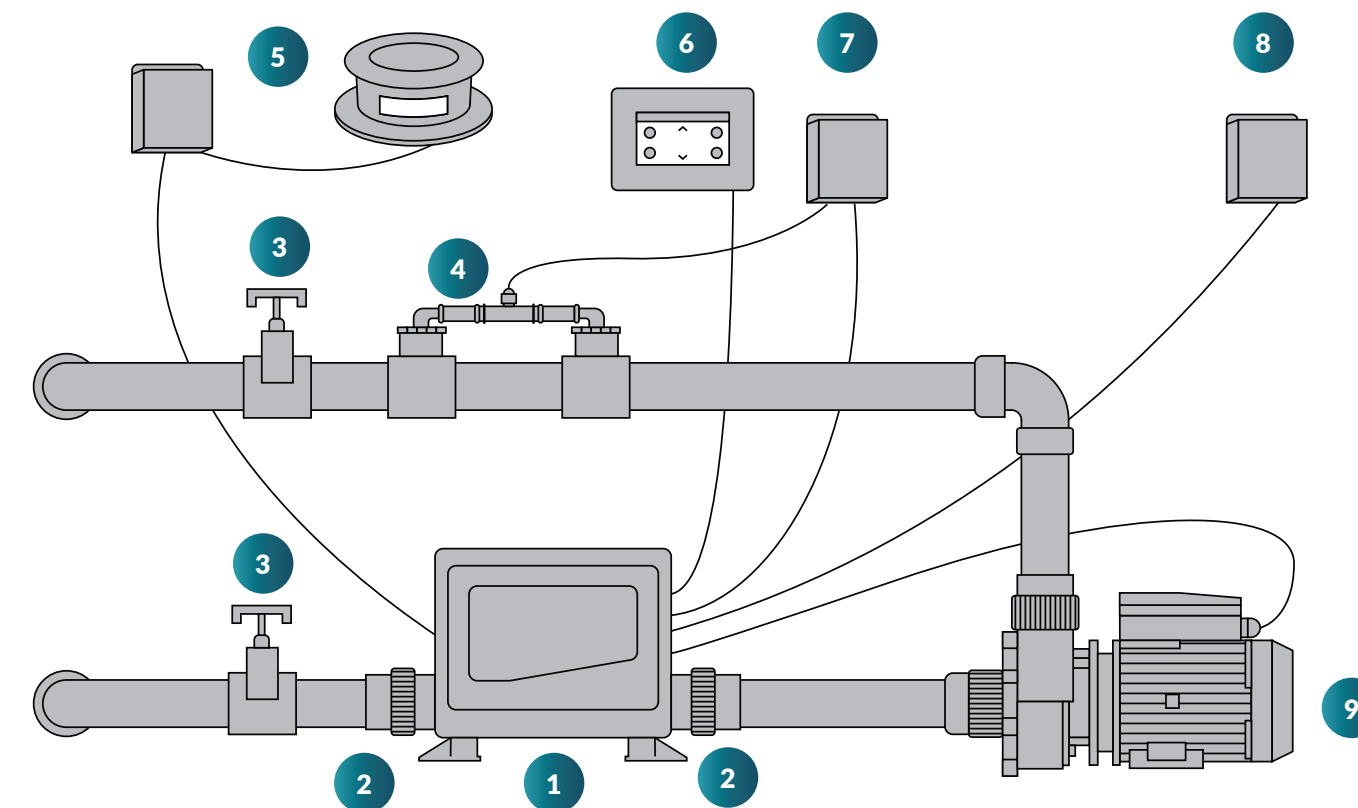

Side view of control device

- | | | |
|-----------------------|-----------------------------|---------------------|
| 1. System control box | 4. Ozone mezz injector | 7. Ozone generator |
| 2. Control box union | 5. Bluetooth unit + Speaker | 8. Light controller |
| 3. Gate valve | 6. System control panel | 9. Circulating pump |

MAINTENANCE

Disassembly and installation of filtration systems

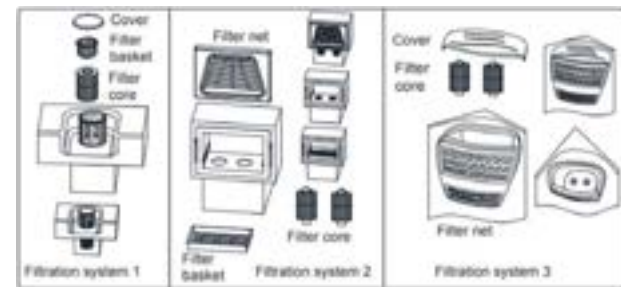

Filtration system 1

- A filtration barrel with a water supply pipe is installed under the filtration and each water hole of the filter is connected with the pipe joint on the filter basket tail. When disassembling the filter, please unscrew the cover counter clockwise first, then catch the handle in the filter basket and put it in a suitable place for cleaning or replacing the filter. A filtration barrel with water supply pipe is installed under the filtration. When disassembling the filter, please pull up the cover first and then take out the filter core for cleaning or replacing it.
- When installing the filter, please catch the handle on the filter and connect each water hole of the filter with the pre-set pipe joint of the filtration cabin. At the same time, press the filter down in its place. Finally, install the cover. Before starting the jet pump, please check whether the filter system is perfectly installed.

Filtration systems 2

- A filtration barrel with a water supply pipe is installed under the filtration. When disassembling the filter core, please first pull up the filter net, take out the filter basket and then the filter for cleaning or replacing the filter.
- When installing the filter, please catch the handle on the filter and connect each water hole of the filter with a pre-set pipe joint of the filtration cabin. At the same time, press the filter down and then push the filter basket into its place. At last, install the filter net. Before starting the jet pump, please check whether the filter system is perfectly installed.

Filtration systems 3

- When installing the filter, please press the filter down in its place and then connect the screw thread joint on the filter basket tail with each water hole of the filter. After that, press the filter basket down in its place. Before starting the jet pump, please check whether the filter system is perfectly installed.

Check the drain valve

To drain the spa:

- Twist the cap clockwise and pull out at the same time (A)
- Once the plug is out fully you can then spin off the cap anti clockwise (B)
- Screw on the hose pipe attachment. Connect the hose, then push in half way to release the valve (C).

At this point the spa will start draining.



DIVERTER VALVE MAINTENANCE

If the diverter valve of your hot tub is difficult to rotate, the reason could be the accumulation of residues in the valve. Please remove such residues as soon as possible to prevent damage to the diverter valve.

In order to do this, please follow these steps:

- Switch off the isolation switch/turn off plug to shut off the power supply to the hot tub
- Lift and shake back and forth to remove the diverter valve handle
- Unscrew top cap
- Pull up and remove the valve body
- Wipe the valve body and the valve inner wall
- Lubricate the O-ring with waterproof lubricants
- Reinstall the diverter valve and turn on the power to the hot tub

Jet maintenance

If you find that the jet rotation speed is slower than usual, or the jet is sticky to turn, the reason could be the accumulation of sediment between the jet and the jet housing.

To remove the sediment, please follow these instructions:

- Unscrew the jet anti-clockwise
- The jet will get to a point where it is hard to turn
- Twist the jet past this point and keep unscrewing until the jet comes out of the housing

- After washing the jet with water, spin the rotary section of the jet (only for rotational jets). Now, the jet should be able to rotate freely. If it can still not freely rotate, you can soak the bearing in a cup of vinegar for one night (cider vinegar can soften any sediment)
- Wash the jet with water on the next day and then carry out a rotation test
- You may also need to clean the jet housing to ensure no sediment is stuck

After these steps are done you can screw the jet back into the jet housing.

NOTE:

If the bearing can still not freely rotate, you need to soak it one more night. If the bearing still does not rotate, you must purchase a new one.

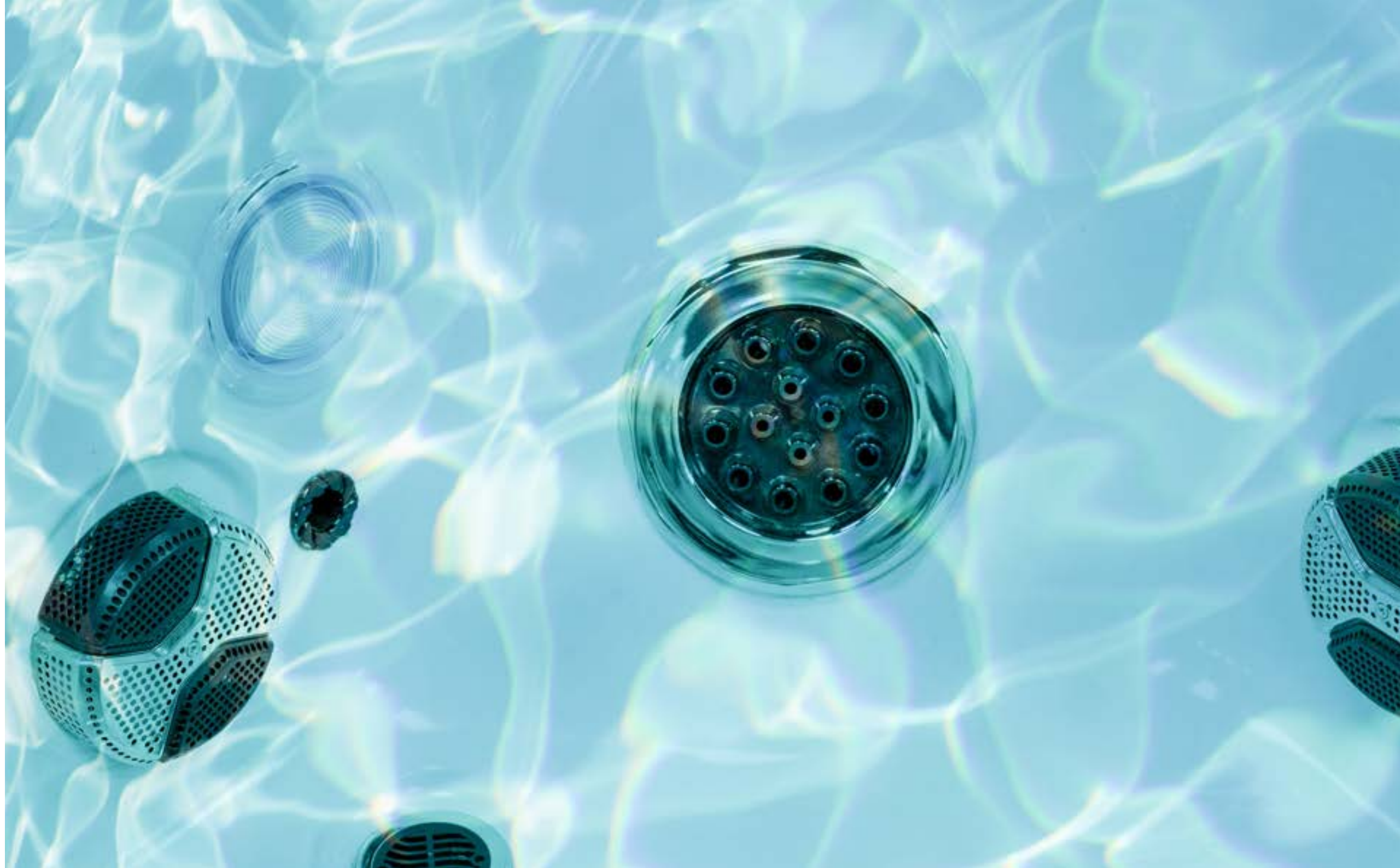

BLUETOOTH

Connecting to your hot tub via Bluetooth has never been easier. Simply follow the instructions below to sync your hot tub to your tablet/device.

Troubleshooting

Quite often, issues with connectivity via Bluetooth is because your phone (or tablet) is already connected to, or in use with another device. Some Bluetooth devices can only connect to one other device at a time; therefore, you'll have to disrupt any current connections before you can link up.

If this approach doesn't solve connectivity issues, we recommend re-establishing the Bluetooth connection by pressing 'forget this device' in settings. To reset bluetooth, the spa will need to be switched off for at least 15 minutes.

IMPORTANT:

Updates to phone software and sound systems may impact connectivity or instructions.



Connecting to your device

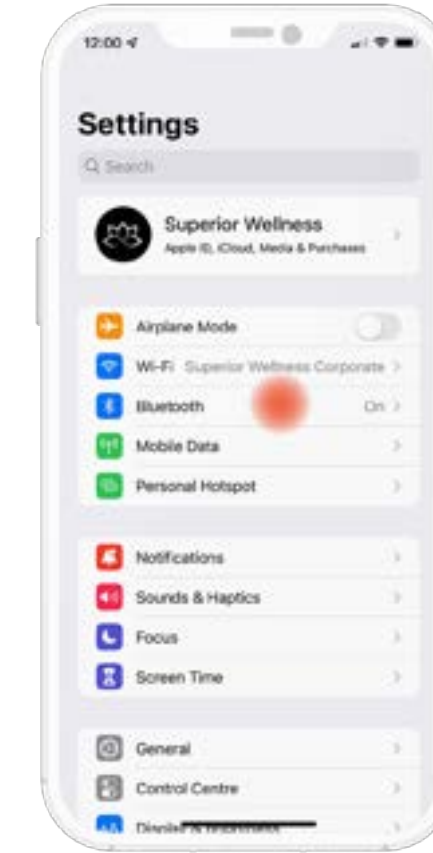

IMPORTANT:

Make sure the devices are in range. To maintain full connectivity, make sure the devices are within at least 20 feet of each other. If you face issues with the quality of your connection, please try bringing the devices closer together.

Step 1:

Make sure the devices are turned on and ready to be connected. On your phone, tablet, or computer make sure that Bluetooth is turned on (you can do this by opening settings, clicking on the Bluetooth menu and tapping the feature on).

Step 2:

Once your device has picked up the pairing with your hot tub, you will be able to select it on the drop down menu for pairing. The name will usually appear on your device as 'JOYONWAY' and the code for your hot tub will be **2288**.

Once all of these steps have been completed, your device and hot tub should be paired, ready for you to begin using this feature.

BLUETOOTH TROUBLESHOOTING

Quite often, issues with connectivity via Bluetooth is because your phone (or tablet) is already connected to, or in use with another device. Some Bluetooth devices can only connect to one other device at a time; therefore, you'll have to disrupt any current connections before you can link up.

If this approach doesn't solve connectivity issues, we recommend re-establishing the Bluetooth connection by pressing 'forget this device' in settings.

IMPORTANT:

Updates to phone software and sound systems may impact connectivity or instructions.

My device is on "search" mode to detect nearby Bluetooth equipment, but does not detect the Bluetooth receiver.

Make sure the audio station is turned on, that you are within range and that the stations Bluetooth is not already connected to a different device.

Despite the fact that my device is within range and that the Bluetooth receiver is turned on with readily available Bluetooth, an error message is displayed when I attempt to pair up or connect a device.

Delete any existing pairing between your device and the audio station, reset all Bluetooth functions on the device you are trying to pair up or connect with the station and start over with the pairing process.

My device is connected, but the music is not playing

In some instances, the Bluetooth receiver will not be able to launch the music application of the connected device. Make sure the music application is open and running on the front page of your mobile device.

My device is connected, but instead of playing from the audio station, the music is playing from my device.

An error might have occurred during your connection with the Bluetooth receiver. Disconnect your device from the station and restart the connection.

The automatic reconnection mode is not working

It is possible that other devices have been connected to the audio station and that the current device is no longer one of the last three connected device or that it has been disconnected using the stations keypad, thus deactivating the automatic reconnection with this device. In this case, you will need to manually reconnect the device to the Bluetooth receiver once to reactivate the automatic reconnection with this specific device.

If everything else fails

It could be that the Bluetooth has remembered too many devices and needs a reset this can be done by forgetting devices on your mobile first and then turn your hot tub off for 5 minutes, and then on again. If you don't leave it 5 minutes, it won't reset the Bluetooth system. Try connecting once more.

Speaker operation

Operation of the pop-speaker:

- push the speaker in the centre and let go, the speaker will slowly rise.
- Press down on the popped-up speaker until the speaker is all the way down. You should hear a click. This means the speaker is locked down.



FILTER CARE

Keeping your filters clean is vital for the safety and longevity of your hot tub. Make sure you dedicate time to cleaning your filters to help keep the water in your hot tub fresh and sanitised.

To help give you an idea of best practice for maintaining your filters, please refer to the filter maintenance schedule below:

Filter FAQs

How often should I clean my filters?

This will depend on your usage, but we recommend you clean them at least once every fortnight. Heavy usage will mean your filters clog up quicker. However, the situation is different when you fill your hot tub for the first time, or whenever you drain and refill your hot tub. In this instance, the filters may clog up within three–four days because of the small particles contained in tap water and any particles from manufacturing/transport.

What will happen if I don't clean my filters regularly enough?

Failure to clean your filters may restrict water flow causing the hot tub to automatically shut down. The following diagnostic messages may appear on your touch pad if your filters are dirty; FLO, Heater Dry, LF, DR, OHH, or -- (two lines). To confirm that the filters are the cause of the problem, remove them and run the hot tub for a few minutes to see if the message clears. If the message still does not clear, try switching the hot tub off whilst the filters are removed, and then back on again.

Please note, you MUST NOT run the hot tub without filters. If the message still appears after trying these measures, please contact a member of the Superior Wellness team to arrange a visit from a technician.

How do I clean my filters?

To clean your filters, we recommend using a hot tub filter cleaner. For optimum results, spray the filter evenly with an instant filter cleaner, wait 15 minutes and then rinse the filter with a hose. An additional recommended cleaning method is to soak the filters in a bucket overnight with a filter cleaner solution. This solution breaks down oils from the pleats and gives the filter a deep clean. Please ensure your filter is air dry before placing back into your hot tub

What filters do I need for my hot tub?

Each hot tub model is different; therefore, it is important you use the correct filter for the hot tub you've purchased. Please refer to our Hot Tub Care and Maintenance guide to check which filter you need.

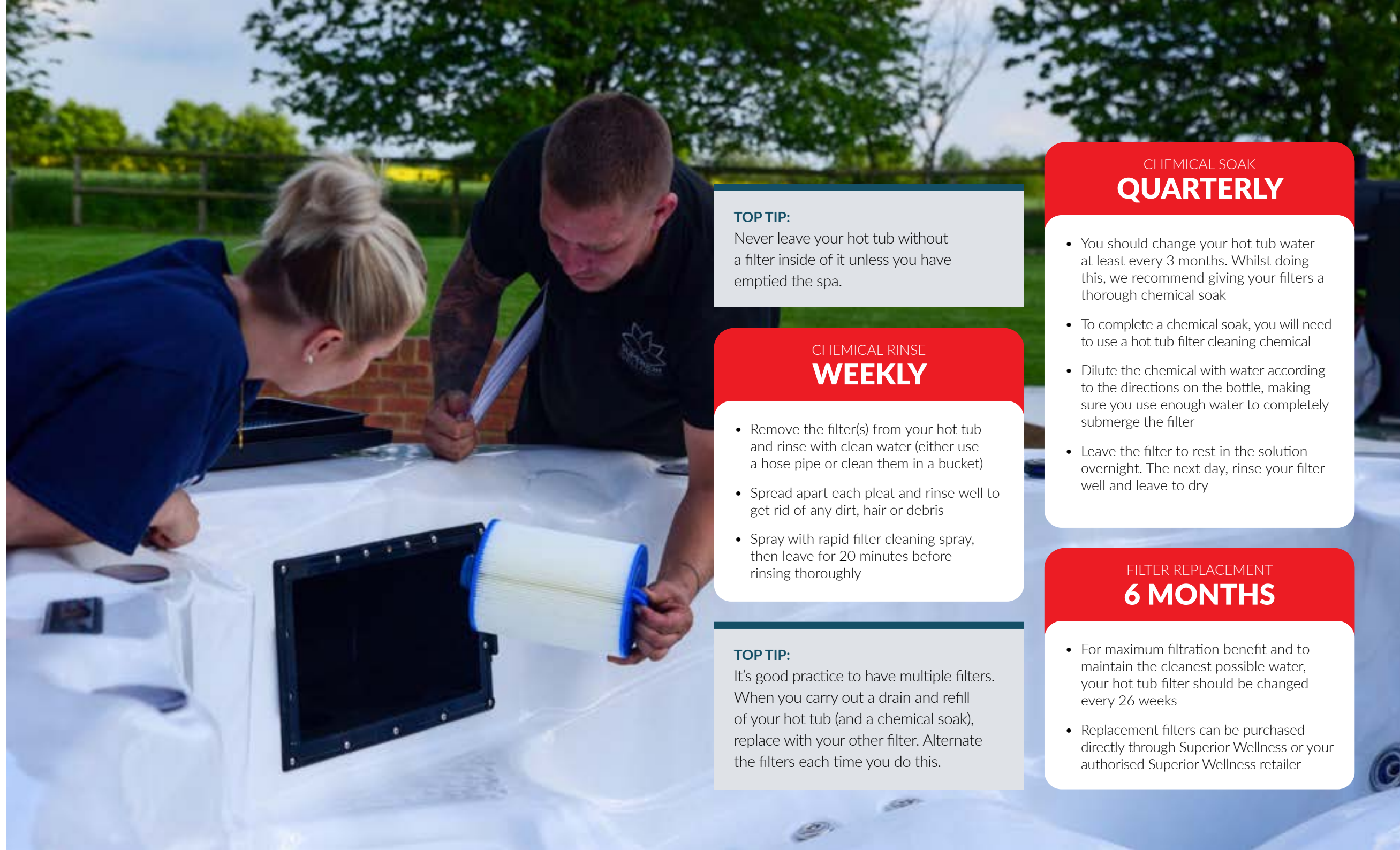

TOP TIP:

Never leave your hot tub without a filter inside of it unless you have emptied the spa.

CHEMICAL RINSE WEEKLY

- Remove the filter(s) from your hot tub and rinse with clean water (either use a hose pipe or clean them in a bucket)
- Spread apart each pleat and rinse well to get rid of any dirt, hair or debris
- Spray with rapid filter cleaning spray, then leave for 20 minutes before rinsing thoroughly

TOP TIP:

It's good practice to have multiple filters. When you carry out a drain and refill of your hot tub (and a chemical soak), replace with your other filter. Alternate the filters each time you do this.

CHEMICAL SOAK QUARTERLY

- You should change your hot tub water at least every 3 months. Whilst doing this, we recommend giving your filters a thorough chemical soak
- To complete a chemical soak, you will need to use a hot tub filter cleaning chemical
- Dilute the chemical with water according to the directions on the bottle, making sure you use enough water to completely submerge the filter
- Leave the filter to rest in the solution overnight. The next day, rinse your filter well and leave to dry

FILTER REPLACEMENT 6 MONTHS

- For maximum filtration benefit and to maintain the cleanest possible water, your hot tub filter should be changed every 26 weeks
- Replacement filters can be purchased directly through Superior Wellness or your authorised Superior Wellness retailer

CLEANING YOUR HOT TUB

It is vital to clean your hot tub on a regular basis. Even if your sanitiser levels are perfect, hot tubs can still develop biofilm. Bacteria feeds on this, which ends up in your water, eating up chlorine and potentially exposing you to contaminants which long-term may cause legionnaires disease and E. coli.

Before emptying your hot tub, we recommend using pipe cleaning fluid called Spa Flush which will clean out the pipework and remove any biofilm. Once added, let the fluid circulate for around 20-30 minutes. If you see foam, don't worry - this means it's working. After the 20-30 minutes is up, you can begin emptying your hot tub (please see page 15 for information on how to empty your hot tub safely).

Whilst your hot tub is draining, we recommend using this time to clean your filter. Simply grab a bucket and fill it with warm tap water. Add some Hot Tub Filter Cleaner to the water, swirl the water slightly to dilute and then submerge the filter. Leave it to soak for 24 hours and then rinse thoroughly with fresh, clean water. You will need to let the filter air dry before placing back in the hot tub. We recommend to use a spare clean filter whilst carrying out this task

Now that your hot tub is empty, spray the shell with a Hot Tub Cleaner fluid (not household cleaning products) and use a microfibre cloth to remove any residue. Don't forget to wipe around the jets too. Rinse all surfaces and drain the rinsed water to prevent foaming when you refill your hot tub. Finally, clean the underside of the cover to protect it and prolong its life.

Draining the water

Water can only be chemically maintained for so long before excess build-up occurs and requires replacement. We recommend draining and refilling your water every three-four months. Prior to emptying, use a hot tub flush to remove any dirt, debris and loosen any calcium from the pipework - this will all be washed away with the drained water. Before you refill your hot tub and use again, we recommend using Spa Surface Cleaner to sanitise and clean the hot tub shell and surface.

To empty your hot tub safely, follow the guidance below:

- Turn off your hot tub completely at the isolation switch. If you have a Plug & Play hot tub, switch off the plug socket
- Once switched off, locate the drainage valve on your hot tub (usually positioned on one of the sides)
- Unscrew this to open it, fit a hosepipe and point the other end towards suitable drainage
- At this point, we recommend adding a submersible pump in the water with your hose close to a drain
- Once positioned, switch the submersible pump on at the main switch
- Allow your hot tub to empty (please note, it could take a couple of hours to fully drain)

TOP TIP:

We recommended you drain your hot tub using a submersible pump - this can be purchased directly with us.

HOT TUB SERVICING

Services are not intended to repair potential faults in your hot tub, but to deep clean, test and make your hot tub a clean and safe place to relax in.

Simply draining and re-filling your hot tub will not tackle the build-up of contaminants within the pipe work. Having your hot tub serviced at least annually will dramatically help towards keeping your hot tub an appealing place to be, giving you the peace of mind that hygiene and safety is maintained.

It is advised that the best time of the year to use a hot tub is in the winter season. However, some customers shut-down their hot tubs over the winter months. It is important to note that solely draining and turning off your hot tub can result in long-term issues. It is advised all customers to fully winterise a hot tub to ensure that damage arising from freezing conditions and poor weather is prevented. Winterising your hot tub correctly will give the best protection during the period your spa is shut-down.

More about your service

Prior to a technician attending the site for a service, please ensure that your hot tub is filled. This is because they will chemically treat the water to flush through the pipework. Once flushed, the technician will drain that water ready for refilling. Access to a water supply will be needed to fill the hot tub; we generally also request that a hose-pipe is available.

Before your service please inform the service technician of any potential issues that you feel they may benefit from, such as restricted space, gazebos, decking or a location with difficult access. This information will allow them to provide you with a more detailed quotation for any non-standard works that may be required.

Where possible the technician will remove and clean each jet internal. However, due to materials deteriorating over time some jets may either be, non-removable or removal of them may cause damage. The technician will always do our best to avoid this and will highlight this to you.

To book a service please contact your local hot tub retailer.

IMPORTANT

The technician will also need access to the main power switch for the hot tub; this is normally known as the RCD and is not the isolation switch located outside.





IMPORTANT INFORMATION

Safety Information – 56

Troubleshooting – 58

SAFETY INFORMATION

All electrical connections must be performed by a qualified electrician.

When installing and using electrical equipment be sure to follow these basic safety precautions:

Danger

- Risk of accidental drowning. Extreme caution must be exercised to prevent unauthorised access by children. To avoid accidents, ensure that children cannot use this hot tub unless they are supervised at all times.
- Risk of injury. The suction fittings are sized to match specific water flow created by the pump. Never operate if suction fittings are broken or missing.
- Risk of Electrical Shock. Install at least 5 feet (1.5m) from all metal surfaces. As an alternative, it may be installed within 5 feet (1.5m) of metal surfaces if each metal surface is permanently connected (bonded) by a minimum ground wire. Do not permit any electrical appliance such as a light, telephone, radio, television, etc. within 5 feet (1.5m) of the hot tub unless such appliances are installed and built-in by the manufacturer.

Warning

- Reduce the risk of injury - do not permit children to use this product unless they are closely supervised at all times.
- Electrical Supply - the electrical supply for this product must include a suitably rated switch or circuit breaker to open all ungrounded supply conductors to comply with the national electrical standards. This disconnect must be readily accessible and visible to the occupant but installed at least 6.5 feet (2m), from the water.

To reduce the risk of injury:

- The water in the hot tub should never exceed 40°C (104°F). Water temperature between 38°C (100°F) and 40°C (104°F) is considered safe for a healthy adult. Lower water temperatures are recommended for young children and when use exceeds 10 minutes.
- If you are pregnant please consult with your doctor before using the hot tub.

- Before entering a hot tub, the user should measure the water temperature with an accurate thermometer since the tolerance of water temperature regulating devices varies.
- The use of alcohol, drugs, or medication before or during use may lead to unconsciousness with the possibility of drowning.
- If you have a history of heart disease, low or high blood pressure, circulatory system problems or diabetes, or you are obese, you should consult a physician before using
- If you are on medication you should consult a physician before using since some medication may induce drowsiness while other medication may affect heart rate, blood pressure, and circulation.
- Prevent Electrocutation. Do not connect any auxiliary components (for example cable, additional speakers, headphones, additional audio/video components, etc.) to system.
- Do not sit on the hot tub or swim spa cover or place objects on it
- After strenuous exercise - do not use the hot tub or swim spa immediately after strenuous exercise

- Pain or dizziness - if you feel pain or dizziness at any time while using the hot tub, discontinue use and contact a doctor
- Pre-existing conditions - to reduce risk of injury it is especially important that persons with pre-existing health conditions or problems such as obesity, heart disease, high or low blood pressure, circulatory problems, pregnancy or diabetes to consult their doctor before using the hot tub or swim spa
- Time limits - observe reasonable time limits when using the hot tub or swim spa. Long exposures at high temperatures can cause high body temperatures. Symptoms may include dizziness, nausea, fainting, drowsiness, and reduced awareness. These effects could possibly result in drowning
- Jets - the jets produce a stream of water with relatively high-pressure. Prolonged exposure of a localised area of the body may cause bruises to the skin
- Risk of drowning - to avoid risk of drowning the hot tub cover should be in place and properly latched when not in use

Caution

Risk of electrical shock:

- With components - replace components only with identical components
- Do not service this product yourself as opening or removing audio covers may expose you to dangerous voltage or other risk of injury. Refer all servicing to qualified service personnel.
- When the power supply connections or power supply cord(s) are damaged; if water is entering any electrical equipment compartment area; if the protective shields or barriers are showing signs of deterioration; or if there are signs of other potential damage to the unit, turn off the unit and refer the servicing to a qualified service personnel.
- Do not operate audio video controls while inside the hot tub
- Do not bring any object into the hot tub that could damage the shell
- Never insert any object into any opening

Important

- Remove any water or debris that may collect on the hot tub cover
- This unit should be subject to periodic routine maintenance (for example, once every three months) to make sure that the unit is operating properly
- Installation of the hot tub for other than a residential dwelling will result in voiding the manufacturer's warranty
- Proper water chemistry is necessary to maintain the water and prevent possible damage to components

TROUBLESHOOTING

If you experience any problems with your hot tub please do not hesitate to contact your authorised hot tub retailer.

Problem	Probable Causes	Troubleshooting Solutions
The hot tub is inoperative	<ul style="list-style-type: none"> Power failure The breaker has tripped Heater's high-limit thermostat has tripped Hot tub lock is activated 	<ul style="list-style-type: none"> Check for problems with your power source Reset the breaker Disconnect the power for 30 seconds to reset the thermostat; then check for clogged filters Deactivate the hot tub lock
Hot tub won't heat, even while the jets and lights operate	<ul style="list-style-type: none"> Air lock was created after filling with water Blocked filters Failed air circulation pump or heater 	<ul style="list-style-type: none"> Remove air locks by loosening pump and/or heater unions Check for blocked filters, try removing filter and see if it heats okay Check for water movement Put pump on/off quickly about 10 times to move air in system
Jet operation is weak or surging	<ul style="list-style-type: none"> Water level is too low Filters are clogged Air control lever is closed 	<ul style="list-style-type: none"> Add water to the hot tub Clean the filters Open the air control lever Turn individual jets if not working
Light is inoperative	<ul style="list-style-type: none"> Spa lock is activated Light wiring or assembly is faulty 	<ul style="list-style-type: none"> Deactivate the spa lock Replace the light assembly
Flo, Htr dry, Dr, Dy displayed	<ul style="list-style-type: none"> Filters may be blocked Circulation pump may have failed 	<ul style="list-style-type: none"> Check and replace/clean filters if needed Is the water in the spa moving? Put pump on/off quickly about 10 times to move air in system

Problem	Probable Causes	Troubleshooting Solutions
Cloudy water	<ul style="list-style-type: none"> Dirty filters Excessive oils / organic matter Improper sanitization Suspended particles / organic matter. Overused or old water 	<ul style="list-style-type: none"> Shock spa with sanitizer Add sanitizer Adjust pH &/or alkalinity range Run jet pump(s) Drain and refill the hot tub
Water odour	<ul style="list-style-type: none"> Excessive organics in water Improper sanitisation Low pH 	<ul style="list-style-type: none"> Shock spa with sanitizer Add sanitizer Adjust pH to rec range
Chlorine odour	<ul style="list-style-type: none"> Chlorine levels too high Low pH 	<ul style="list-style-type: none"> Shock spa with sanitizer Adjust pH to recommended range
Musty odour	<ul style="list-style-type: none"> Bacteria or algae growth 	<ul style="list-style-type: none"> Shock spa with sanitiser (if problem is visible or persistent, drain, clean and refill the spa)
Organic build up or ring around spa	<ul style="list-style-type: none"> Build-up of oils and dirt 	<ul style="list-style-type: none"> Wipe off scum with clean rag (if scum ring around spa is severe, drain the spa, use a spa surface and tile cleaner to remove the scum and refill the spa)
Algae growth	<ul style="list-style-type: none"> High pH Low sanitizer level 	<ul style="list-style-type: none"> Shock spa with sanitizer & adjust pH Shock spa with sanitizer Maintain sanitizer level
Eye irritation	<ul style="list-style-type: none"> Low pH Low sanitizer level 	<ul style="list-style-type: none"> Adjust pH Shock spa with sanitizer Maintain sanitizer level
Skin irritation / rash	<ul style="list-style-type: none"> Unsanitary water Free chlorine level above 5ppm 	<ul style="list-style-type: none"> Shock spa with sanitizer Maintain sanitizer level Allow free chlorine level to drop below 5ppm before spa use
Stains	<ul style="list-style-type: none"> Total alkalinity and pH too low High iron or copper in water source 	<ul style="list-style-type: none"> Adjust total alkalinity and/or pH Use a metal deposit inhibitor
Scale	<ul style="list-style-type: none"> High calcium content in water Total alkalinity and pH too high 	<ul style="list-style-type: none"> Adjust total alkalinity and pH If scale requires removal, drain the spa, scrub off the scale, refill the spa and balance the water



Superior House,
Broombank Park,
Chesterfield,
S41 9RT

01246 559071
info@platinumspas.co.uk
www.platinum-spas.com

Get social with us:

